

TELEPHONE SETS — 5300 SERIES  
 IDENTIFICATION AND ASSEMBLY OF PARTS

1.00 INTRODUCTION

1.01 This section covers the identification and the assembly of parts of the 5300 series telephone sets.

1.02 Information pertaining to the several components which have been added or changed in the conversion will be included in this section.

2.00 GENERAL

2.01 The 5300 series telephone set is a conversion, by the Western Electric Company, of 302G, 304C, and 306C telephone sets to approach the appearance and performance of the 500 series telephone sets.

2.02 The numbering scheme for the 5300 series was derived by preceding the number of the set in the 300 series with the digit 5. For example, the 302G-3 set after being converted would become the 5302G-3 set.

2.03 Components not affected by the conversion will be covered in the C Section covering the assembly of parts of the 300 series telephone sets.

2.04 Replacement of coded components, if required, shall be in accordance with Table A.

TABLE A  
 5300 SERIES COMPONENTS

Tel. Set.	Housing	Mtg. Cord	Hand-set	Dial	Dial Adapter	No. Plate	No. Ring	Capacitor	Ind. Coil	Ringer	El Tube	Filter	Hand Hole Cover	Switch Assembly
5302G	P-18A921	D3AY D3AA	G1A F1G F4A	6H* 5M	59A	164C-3	P-18A974	195A	101A	B1A B1A	—	61S	P-18A965	P-290500
5304C									101B	B2A B2A				P-290501
5306C									195C	101A				B3A†

Note: When more than one code of apparatus or piece part is listed as suitable for replacement purposes in Table A, and local stock on any of these is not available, order that which is boldface.

\*Unless otherwise specified, 6H dial shall be used on sets equipped with F4- or G-type handsets.

†The 41A gong of the B3A ringer shall be equipped with a 101A gong attachment with a solid cover.

3.00 IDENTIFICATION

The 5300 series telephone set is for use in dial areas only.

- It is approximately 1/4 inch less in depth than the 500 series set.
- It provides adjustable ringer volume control.
- New housing permits use of F- or G-type handset.
- Bracket is provided for mounting electron tube.



FIG. 1A—EXTERIOR VIEW

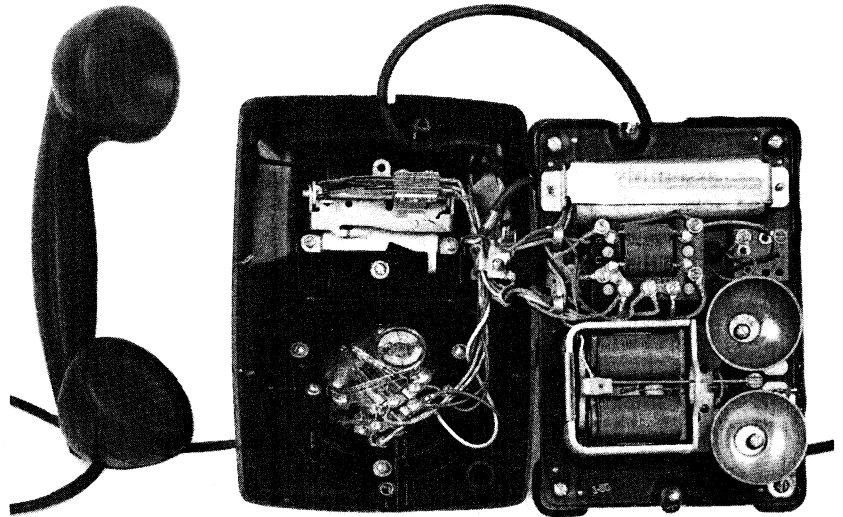

FIG. 1B—INTERIOR VIEW

5300 SERIES TELEPHONE SET

4.00 ASSEMBLY OF PARTS

CORD ANCHORS AND CORDING

4.01 An additional cord anchor is provided permitting cords with either stay cord hook or S hook to be terminated. Fig. 2A shows the new mounting cord for G-type handset, and Fig. 2B shows old mounting cord for G-type handset.

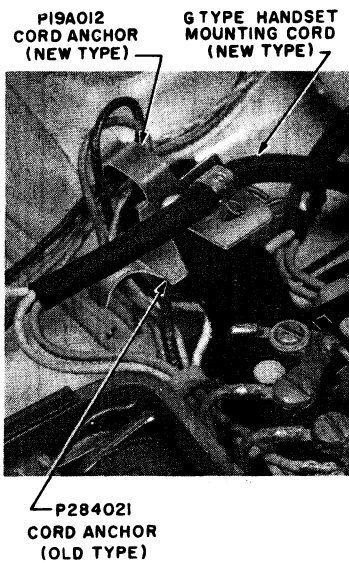

FIG. 2A—OLD TYPE CORD

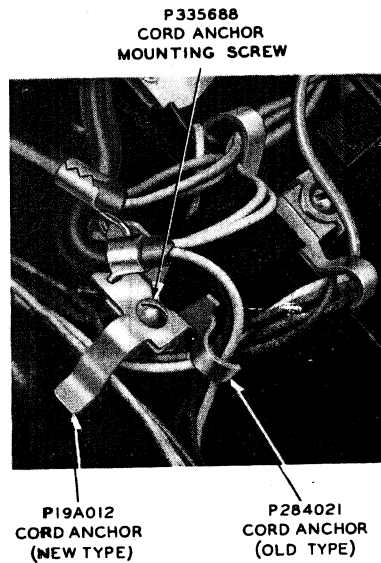

FIG. 2B—NEW TYPE CORD

CORD ANCHORS

DIAL

4.02 This set is equipped with a standard 5- or 6-type dial having a 164C-3 number plate.

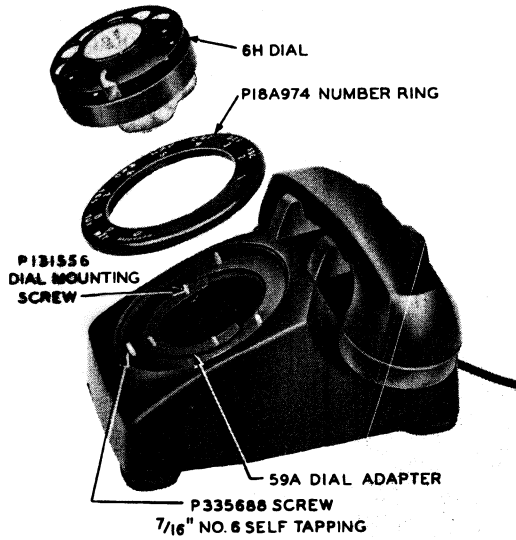

FIG. 3—DIAL ASSEMBLY

ELECTRON TUBE BRACKET

4.03 The electron tube bracket for the 5306-type telephone set is placed as shown in Fig. 4.

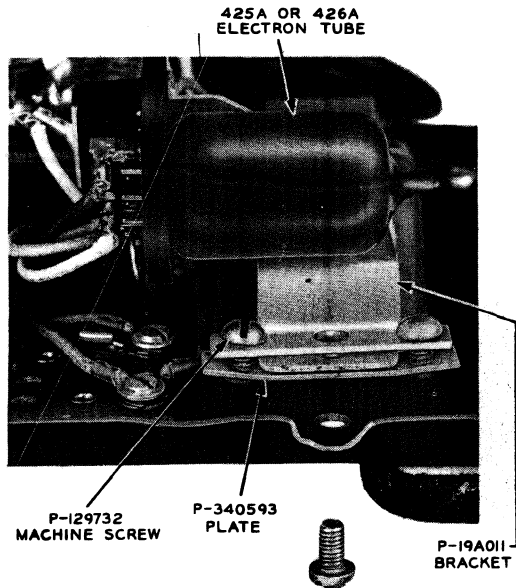

FIG. 4—ELECTRON TUBE BRACKET ASSEMBLY

FILTER

4.04 This set may be equipped with a 61S filter as shown in Fig. 5.

SWITCHHOOK

4.05 The switchhook assembly for this series is shown in Fig. 5.

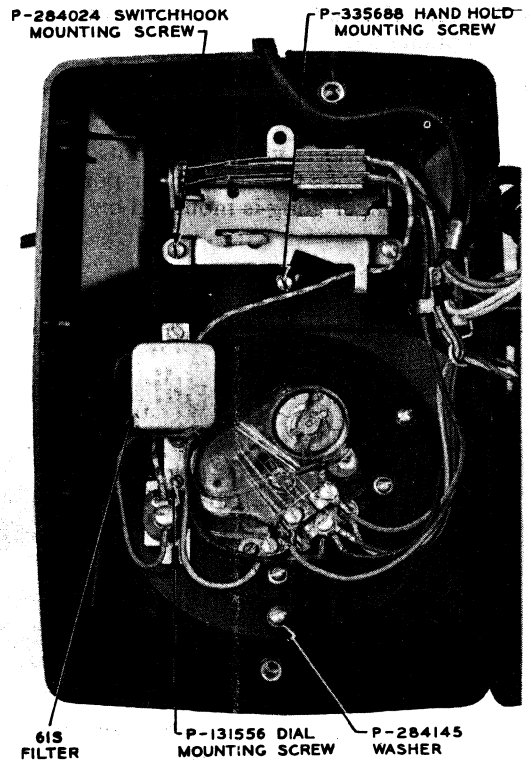

FIG. 5—FILTER AND SWITCHHOOK ASSEMBLY

HOUSING

4.06 The handset cradle of the housing for the 5300-series telephone set will accommodate the F- and G-type handsets. A recess is provided for the F-type handset. The housing is fastened to the webbing of the base by means of the cord anchor screw.

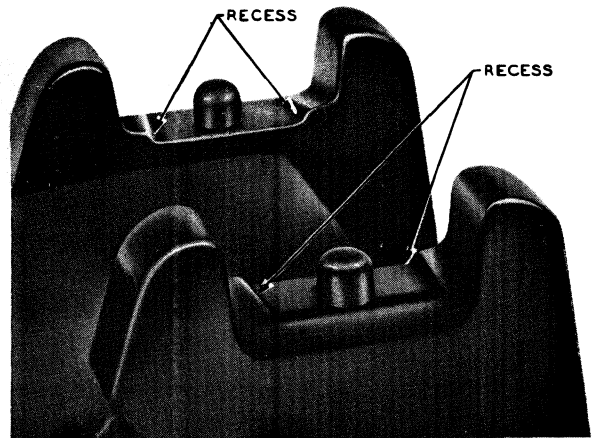

FIG. 6—CRADLE RECESS

RINGER VOLUME CONTROL

4.07 The ringer volume control assembly is provided on all 5300 series telephone sets.

- Washer P-10E127 is not required on 5306C telephone sets.
- Assembly must be removed in order to replace ringer.
- Ringer volume is varied by control arm lever which protrudes through ringer port in base of set. Left ringer gong is mounted on gong end of

control arm and may be moved to three positions, low, medium, and high, by operation of volume control lever (see Figs. 7 and 8).

- To remove assembly, remove mounting screw which also mounts the right front foot to the base; move assembly toward front of base and lift up to disengage mounting bracket ears and hook which aid in holding assembly in place.
- When placing assembly, mounting bracket hook and ears must be in place before mounting screw is secured.

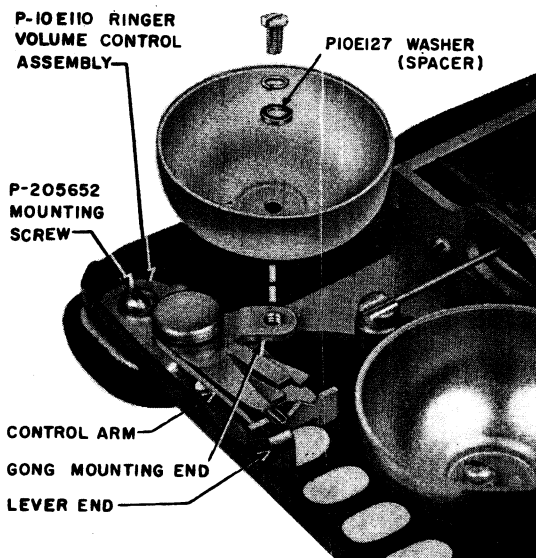

FIG. 7—RINGER VOLUME CONTROL ASSEMBLY

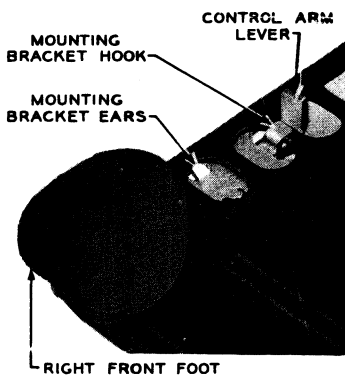

FIG. 8—MOUNTING BRACKET